

H Series

EN

**User's
Manual**



WELCOME

EN

Dear Valued Customer,
We are delighted to welcome you to the Voltsmile family! By choosing our energy storage batteries, you have taken a significant step towards efficiently managing your home power systems and living a more eco-friendly lifestyle.

Our energy storage batteries are designed to help you make the most of your solar power system. With Voltsmile batteries, you can store excess solar power generated during the day and use it during the night or peak hours, reducing your reliance on the grid and saving on electricity bills. Not only does this help you save money, but it also allows you to reduce your carbon footprint, as you rely less on fossil fuels and more on clean, renewable energy.

Everyone has a part to play in creating a sustainable future for our planet, and we are proud to offer products that contribute to this goal. We are committed to providing you with the highest quality energy storage batteries and exceptional customer service.

If you have any questions or concerns about your new Voltsmile energy storage batteries, our experts are always here to help. We want to ensure you have a seamless experience with our products and are getting the most out of your investment.

Once again, we welcome you to the Voltsmile family and look forward to serving your energy storage needs.
Sincerely,

The Voltsmile Team.

Precautions

The H series battery systems offer many benefits, such as improved efficiency and reduced emissions. It is essential to take certain precautions to ensure safety. Here are some general precautions for using H series battery systems:

1. Always follow Voltsmile's instructions and guidelines for using and maintaining the battery system.
2. Wear appropriate personal protective equipment, such as insulated gloves and safety glasses, when working with high-voltage battery systems.
3. Ensure that the battery system is installed correctly and grounded and that all electrical connections are secure.
4. Do not attempt to disassemble or modify the battery system, as this can result in electric shock or other serious injuries.
5. If the battery system is damaged or shows signs of malfunction, such as leaking or swelling, stop using it immediately and seek professional assistance.
6. Avoid exposing the battery system to extreme temperatures or environmental conditions that could cause damage or degradation.
7. Always turn off the power supply before connecting or disconnecting the battery system, and never touch the electrical contacts with bare hands or metal tools.

These precautions ensure that H series battery systems are used safely and effectively in various applications.

WARNING!



THIS SYSTEM CONTAINS HIGH-VOLTAGE BATTERY



WARNING:

Installation and maintenance should only be carried out by trained professionals. We do not undertake any consequences or related responsibility because of violation of safety operation or violation of design, production and equipment safety standards.



CAUTION:

1. It is required to charge the battery at least once every six months. For this charge, maintenance ensures the SOC is higher than 90%.
2. The connection of the power connector, grounding point, power cable and screw are suggested to be checked yearly. Ensure there is no loose, broken, or corrosion at the connection point. Check the installation environment, such as dust, water, insect and more, to ensure it is suitable for the IP65 battery system.
3. If the battery is stored for a long time, it must charge every six months, and the SOC should be higher than 90%.



In case a battery (normal condition or damaged) needs disposal or needs recycling, it shall follow the local recycling regulation (i.e. Regulation (EC) Number 1013/2006 among European Union) to process and use the best available measures to achieve relevant recycling efficiency.

Before Start:

1. Please read this user's Manual thoroughly.
2. The H series must be installed against load bearing wall.
3. The H series weighs at least 110kg, and we recommend that at least two people for the installation.
4. Ensure that the site is suitable for the installation, considering factors such as space, ventilation, and accessibility.
5. Conduct a thorough risk assessment to identify potential hazards and develop appropriate mitigation measures.
6. Choose a official supplier of Voltsmile that can provide genuine battery systems and professional installation services.
7. Ensure that the electrical infrastructure can handle the high voltage and current of the battery system and that all electrical connections are properly installed and grounded.

Tools for installation:

1. Tape Measure.
2. Marking Tool.
3. Power Drill.
4. Socket Wrench.
5. Screw Driver.

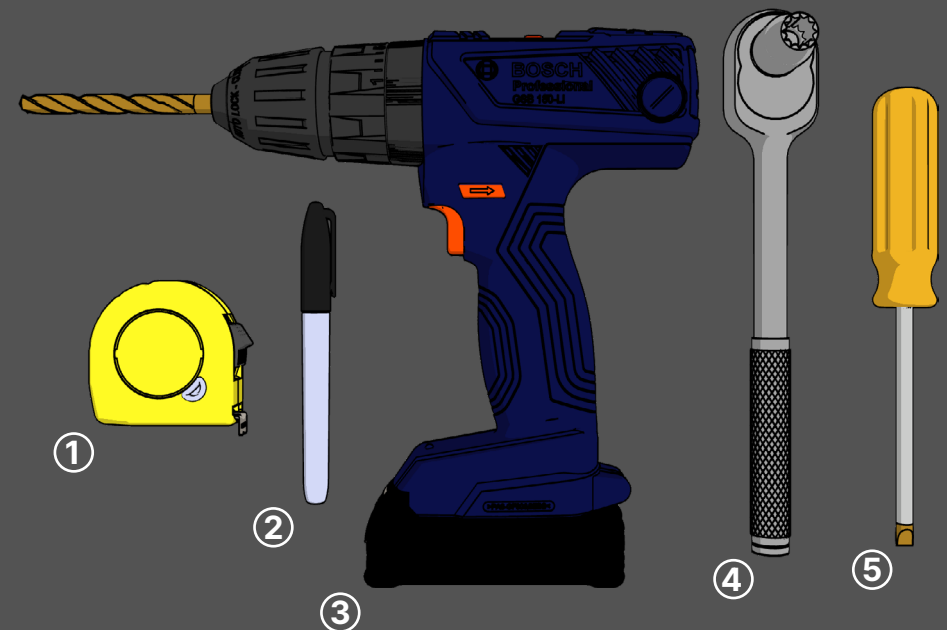

- 1 Unpack the **Base A** package first.

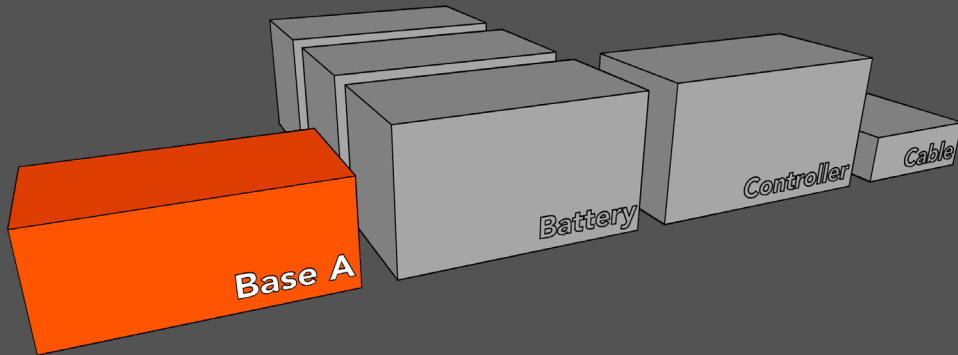

- 2 Place the **Base A** against the load-bearing wall at the designated area.

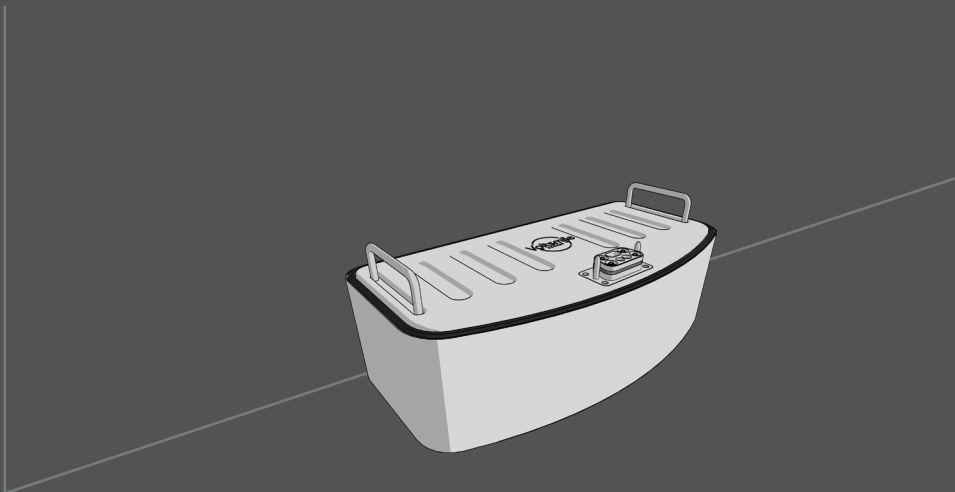

- 3 Unpack the **Controller** package and take the **Wall Bracket** and the **Concrete Anchors** out.

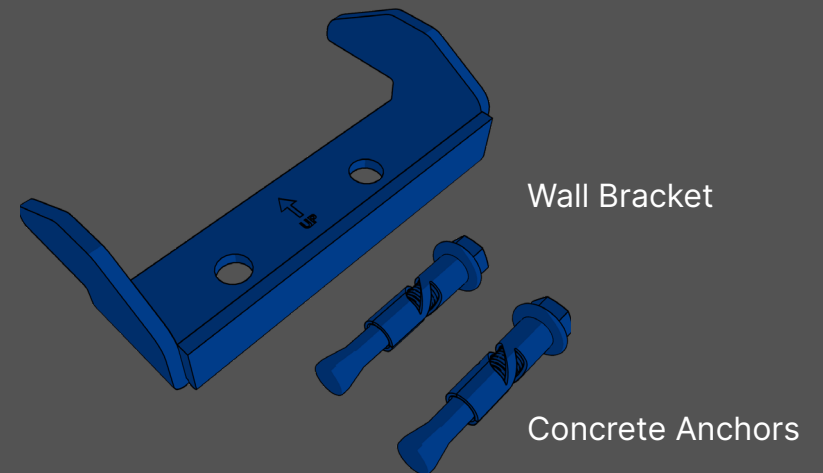
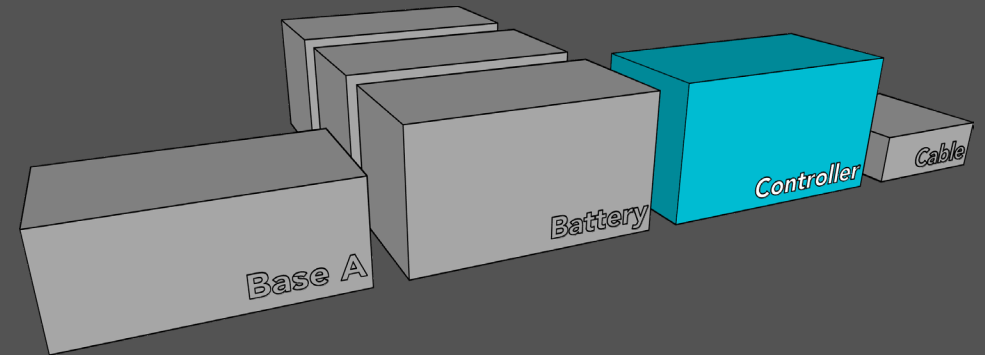

Installation

03

- ④ Mark **87cm** from the top of the **Base A** with a tape measure and make a marking on the wall. (**Three Battery modules**) Align the **87cm** Marking with the bottom line of the **Wall Bracket**.

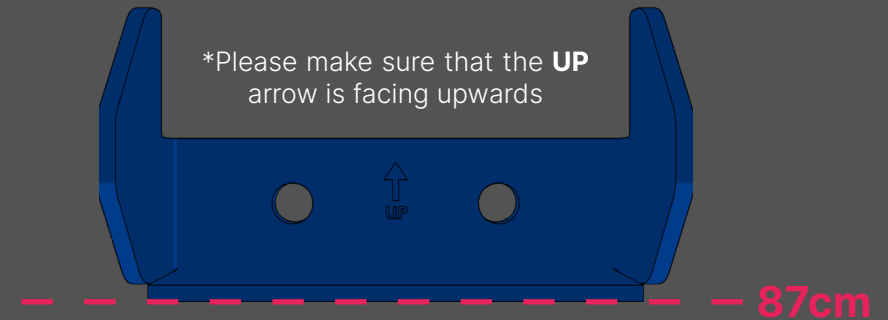
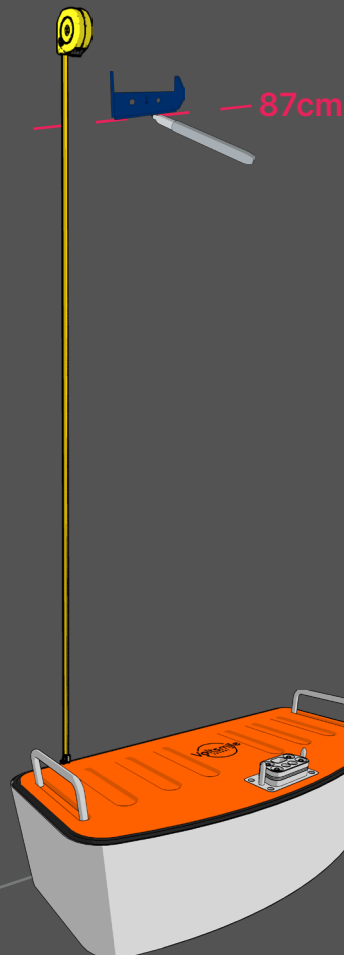

- With 2 battery modules: 63 cm
- With 3 battery modules: 87 cm
- With 4 battery modules: 111 cm
- With 5 battery modules: 135 cm
- With 6 battery modules: 159 cm

THIS MEASUREMENT IS ONLY SUITABLE FOR THE MAIN CLUSTER (THE CLUSTER WITH THE CONTROLLER UNIT).

WE RECOMMEND USING BASE A FOR REFERENCE TO HAVE THE MOST ACCURATE MEASUREMENT.

WE RECOMMEND NOT INSTALLING MORE THAN SIX BATTERY MODULES ON A SINGLE CLUSTER.

Installation

04

- ⑥ Mark and drill two holes with a 10mm drill bit 6cm deep.

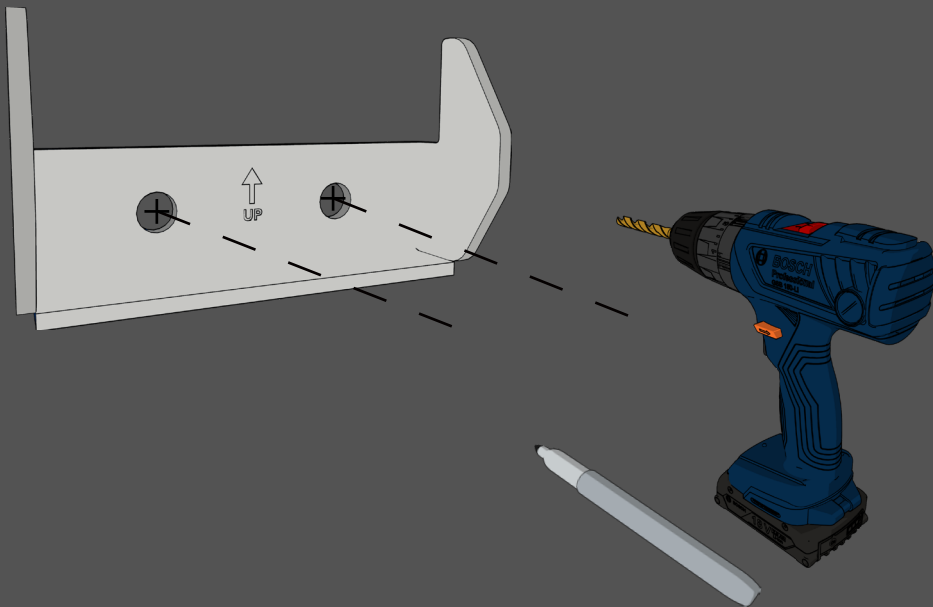

- ⑦ Gently tap the **Concrete Anchor** into the holes and secure them with a socket wrench or a spanner.

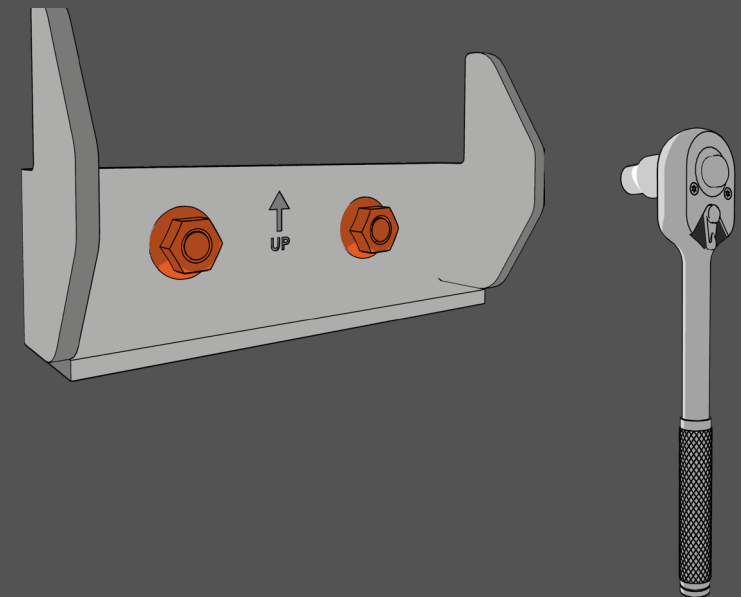

Reminder:

PLEASE REMOVE THE BASE A OR FULLY COVER UP THE BASE A BEFORE DRILLING THE HOLES TO PREVENT DUST AND RESIDUES TO CUNMULATE.

- 8) Unpack Battery Modules individually and stack them onto the Base A.

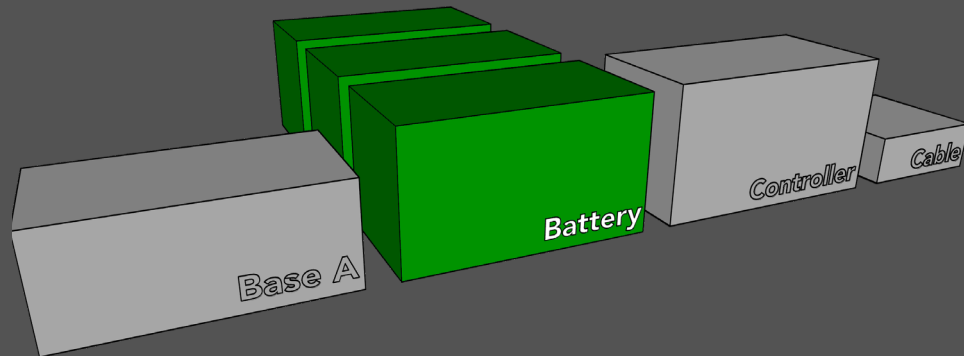

Reminder:

PLEASE NOTE THAT EACH BATTERY MODULE IS AROUND 43KG; FOR HEALTH AND SAFETY REASONS, WE RECOMMEND THAT ITS BEST CARRIED BY TWO PEOPLE.

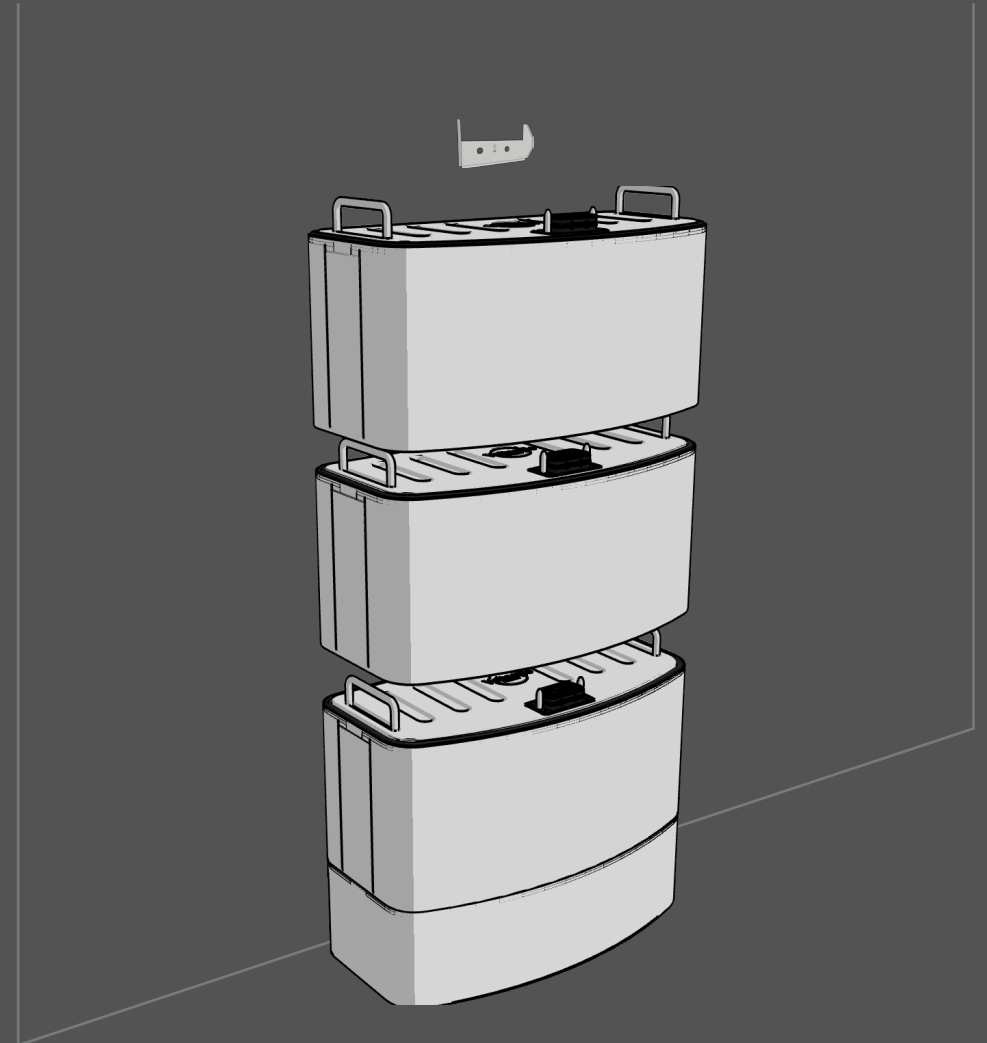

Installation

06

- 9 Unpack the **Controller** package, attach it to the top of the battery modules, carefully align the wall bracket with the backplate on the **Controller**, and secure it in place.

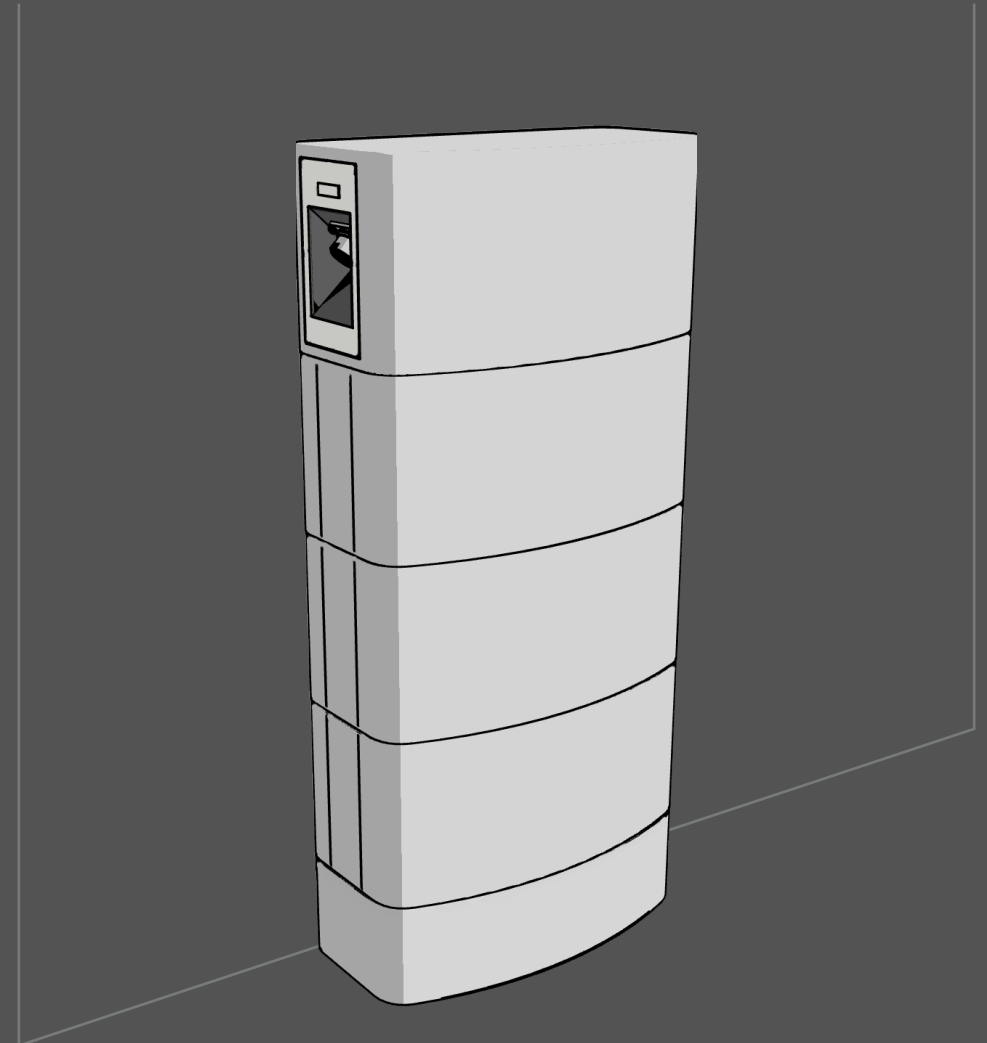
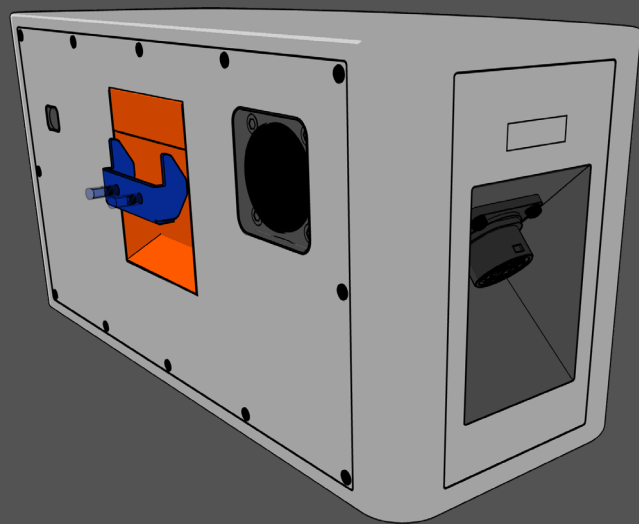
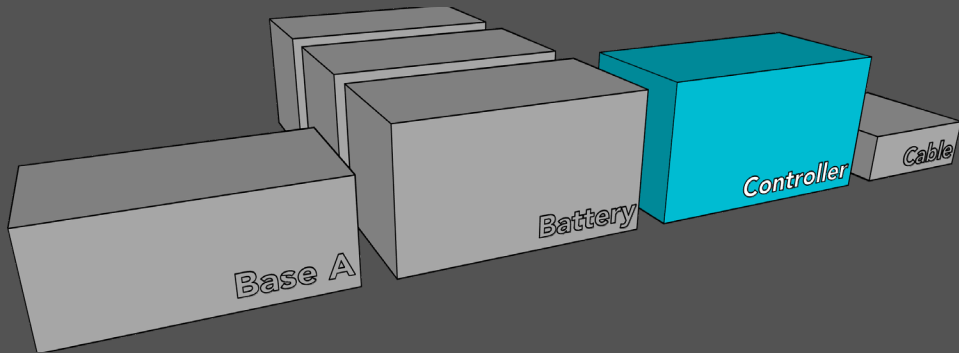

- 1 Unpack the **Cable** package, and inside you will find the Power and Data Cable and a Grounding Cable. (both at default configuration will be two meters long)

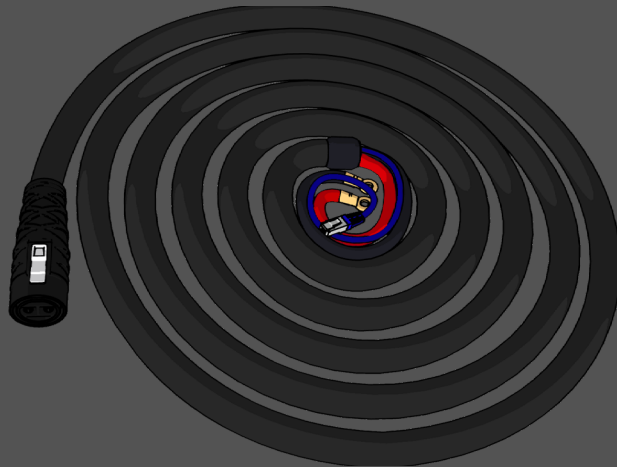
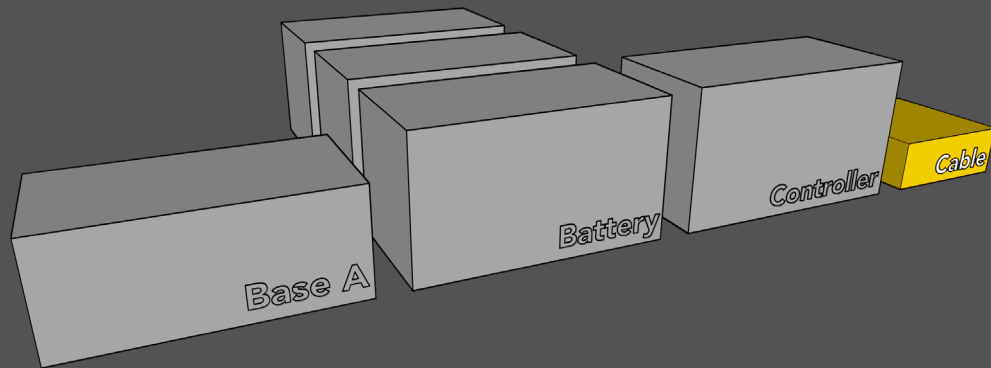

Power and Data Cable

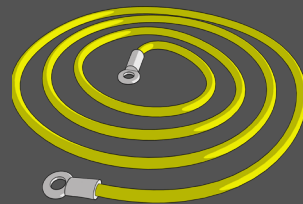

Grounding Cable

- 2 As Shown, you will find a **hatch door** on the side of BASE A, which has two screw sockets with Grounding markings, wire the grounding cable on either of these holes and connect the grounding cable to the earth.

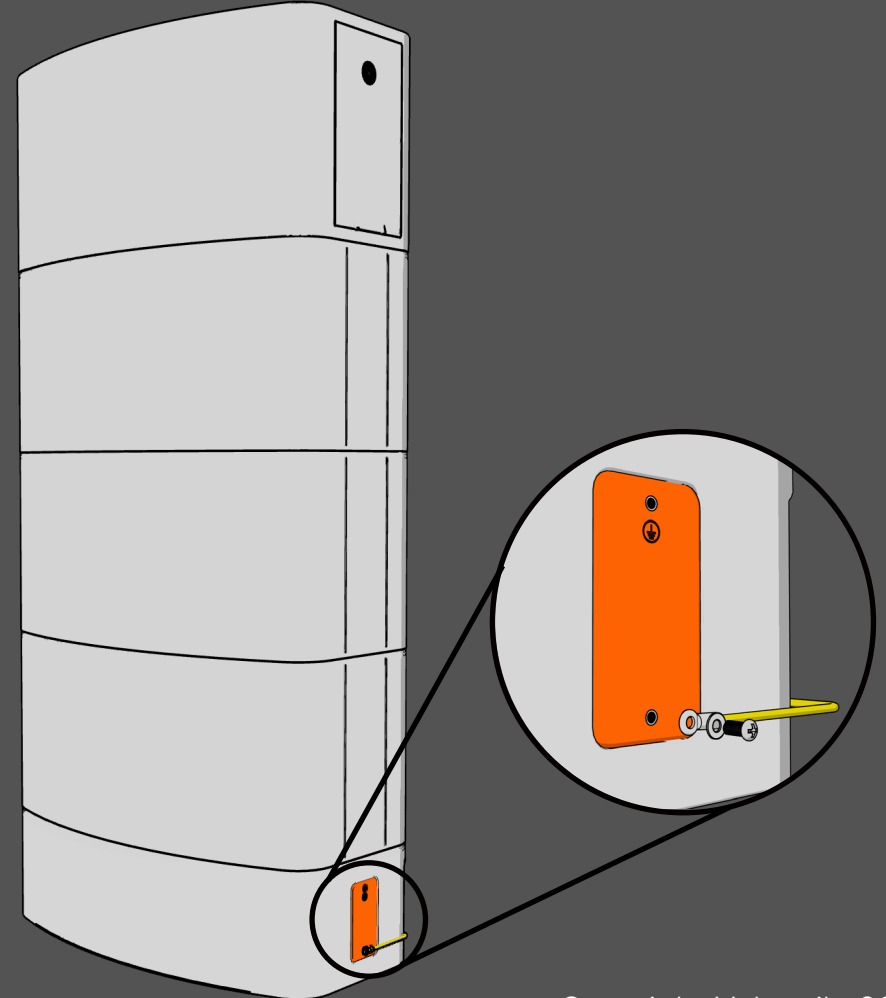

- 3 Plug the **Power and Data Cable** into the Controller till you hear the 'Click'. Make sure that the metal clip on the plug is facing up.

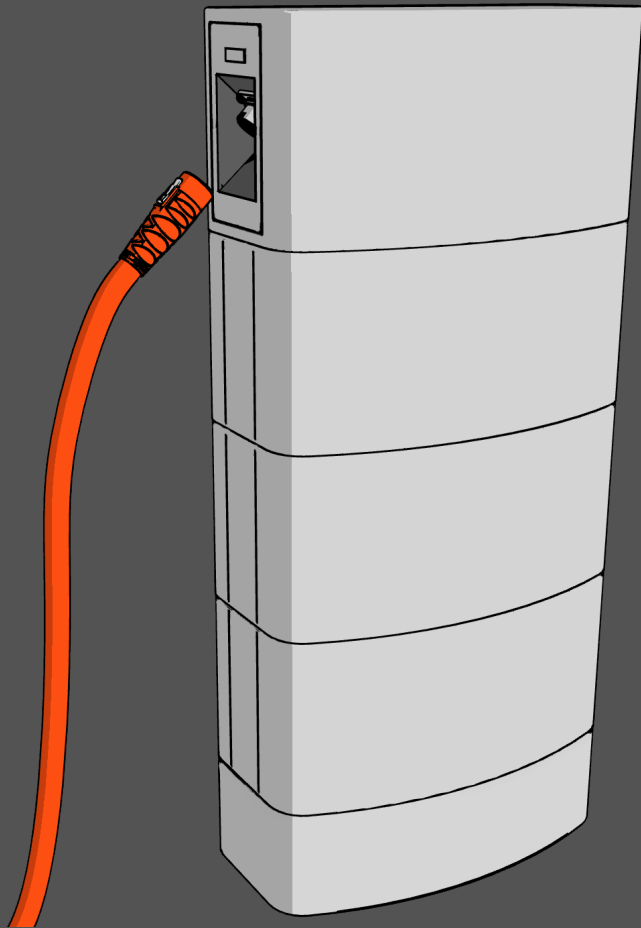

- 4 Connect the Power and Data Cable to the inverter, please note that you should always check with the inverter's wiring guide before connecting, and the inverter should be turned OFF before you start.

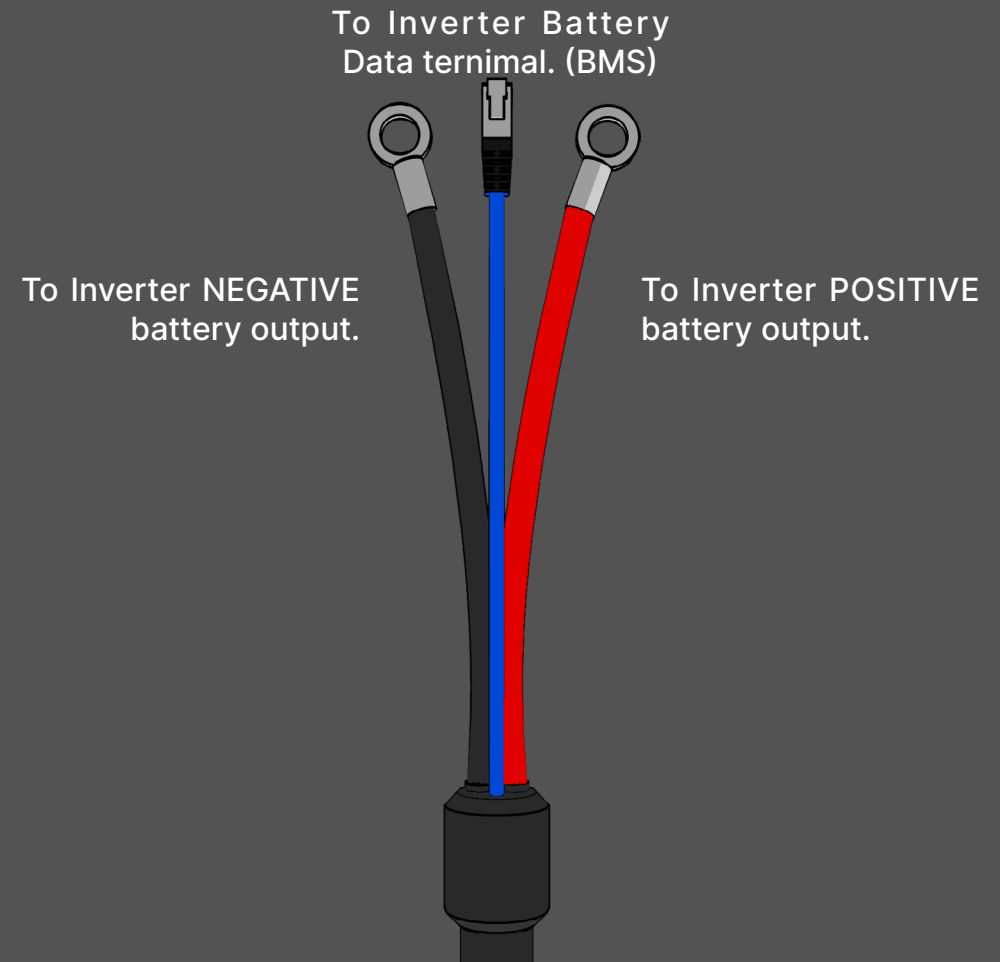

- ① Detach the magnetic **hatch** on the side of the controller, flip open the **protective cover** for the breaker, and turn the breaker on by pushing all the **levers** upwards.

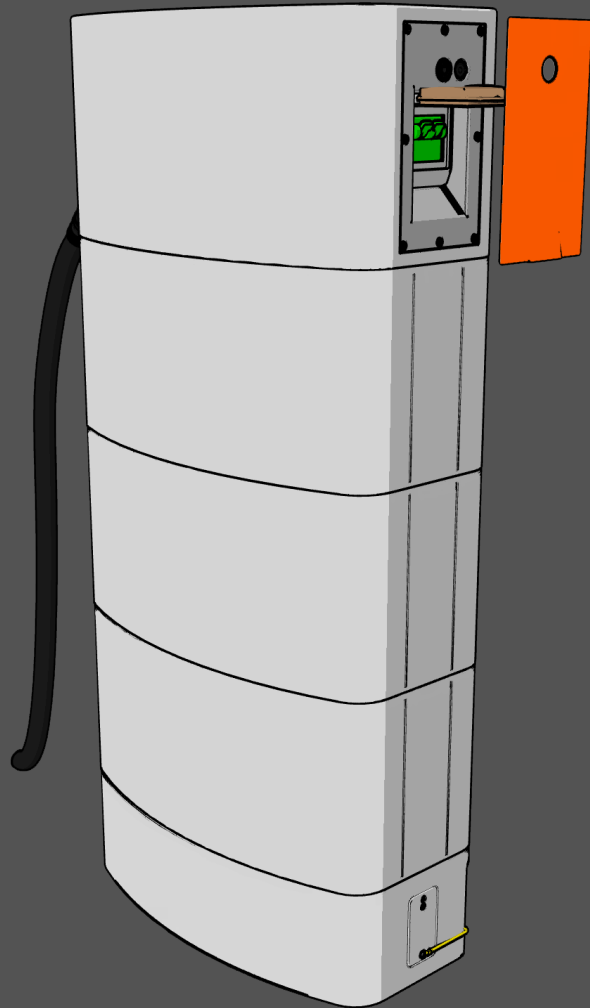

- ② Flip back the protective cover and reattach the magnetic hatch, press the **Power Switch Button** on the side of the controller, and your H series should be up and running.

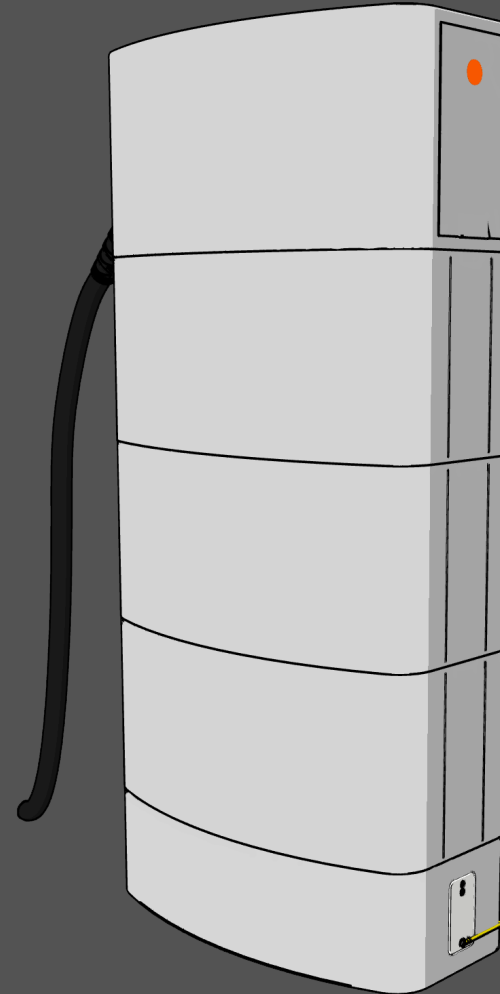

Apps & Settings

- 1 Find Voltsmile BESS by Udan Tech on either Apple App Store or Google Play store.

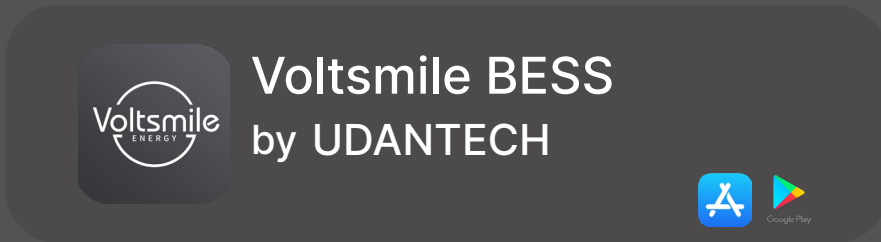

- 2 After installation, please create a user account, and follow the instruction to login.

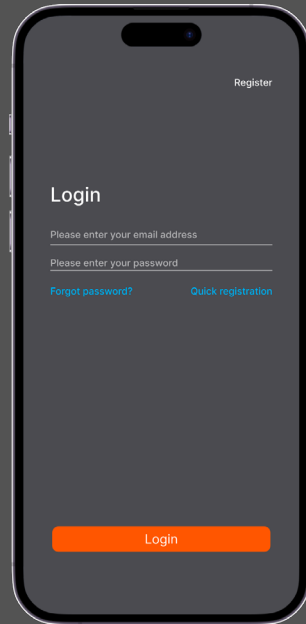
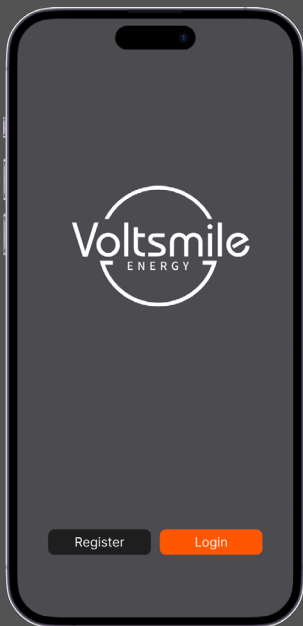

- 3 After login, please check for app update under the user info tab, and make sure you are running the latest app version.

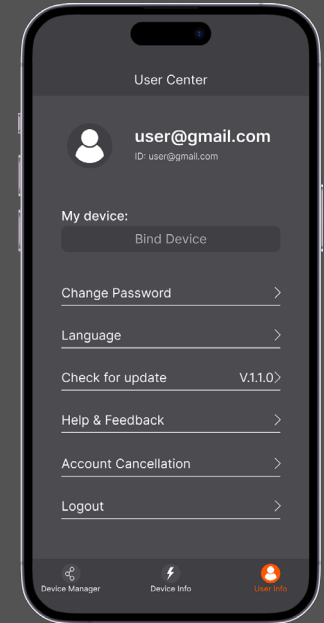

- 4 Scan the unique QR code for your H series battery system and bind it to your account. (Please be in Bluetooth range with the H series)

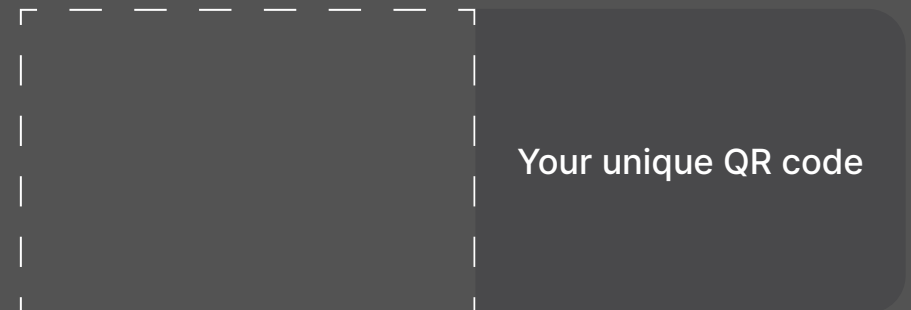

- 5 After scanning the QR code, App will ask for Bluetooth connection permission on your phone. After enabling Bluetooth, you will be greeted with the config page where we recommend configuring your WiFi at this stage, or if you choose not to, you can check your battery stats by clicking Dashboard, but only within Bluetooth range.



- 6 If you choose to connect to your WiFi network, please click WiFi Config. The App will then ask WiFi password for your network. (H series only work with a 2.4 GHz WiFi network.)

- 7 Once connected to the WiFi, you can monitor your H series System anywhere worldwide and upgrade its firmware wirelessly.

- 8 All done, enjoy!

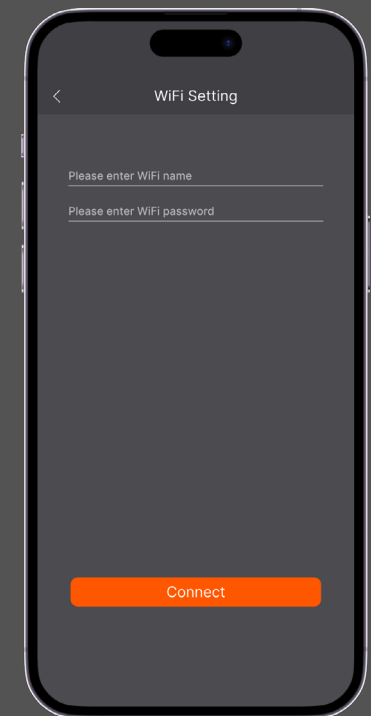

Upgrades

12

H series is expandable from 10kWh up to 60kWh. Ask your local dealer for more information if you need to expand your setup.



Voltsmile B.V. The Netherlands
Shenzhen Voltsmile Energy Technology Co.,Ltd
Huizhou Voltsmile Energy Technology Co.,Ltd
Dongguan Voltsmile Energy Technology Co.,Ltd
Shenzhen Londian Watson Holdings Group Co.,Ltd

